



landscape • entertainment • architectural • hospitality • illumination

RXP-03/04 SERIES **NEW** PATH LIGHTS



RXP-03-LED-BRS



RXP-03-LED-BRS



RXP-03-LED-BRS



RXP-03-LED-BRS

25301 COMMERCENTRE DRIVE • LAKE FOREST, CA 92630 • 949.830.1350 • 888.882.1350 • FAX 949.830.3390



PATH LIGHTS RXP-03/04 SERIES



TYPE

SPECIFICATIONS

CONSTRUCTION: Machined brass cylinder with threaded cap & cast brass adjustable swivel. Brass stem

LENS: Clear tempered glass

O-RING: High temperature red silicone

LAMP SUPPLIED RXP-03: 20w MR16 FL(BAB) 5000 hours average rating (20w max)

LAMP SUPPLIED RXP-04: 2x 20w MR16 FL(BAB) 5000 hours average rating (40w total max)

LAMP OPTIONS: We recommend 40,000 hour 3w, 5w or 7w ARROW Super Saver LED

SOCKET: High temperature ceramic GU5.3 bi-pin with 250°C silicone lead wires

WIRING: Black and 2 White 250°C silicone lead wires

CONNECTION: FA-05 Quick Connector (not supplied) from fixture to main cable (12/2, 10/2 or 8/2 only)

MOUNTING: FA-03- LG Large black 9" ABS stake, tapped 1/2" NPS

FINISH: Brass-Unfinished brass. Optional finishes available



RXP-03-BRS

RXP-04-BRS

IP65



ORDERING INFORMATION

CATALOG NO.	DESCRIPTION	LAMP	SHIP WEIGHT
RXP-03-BRS	1x 20w MR16 Brass Path Light	20w MR16 FL(BAB)	4.0 lbs.
RXP-04-BRS	2x 20w MR16 Brass Path Light	20w MR16 FL(BAB)	5.0 lbs.

MOUNTING ACCESSORIES

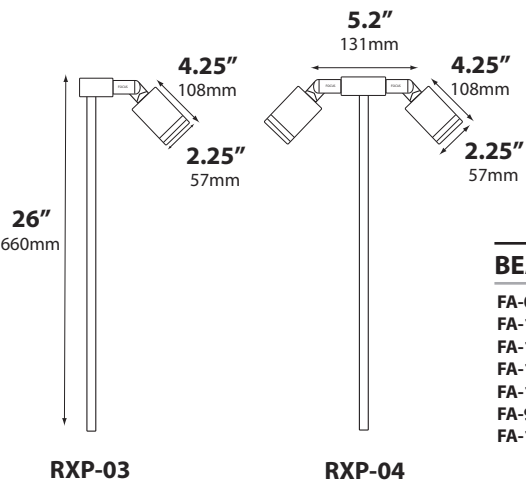
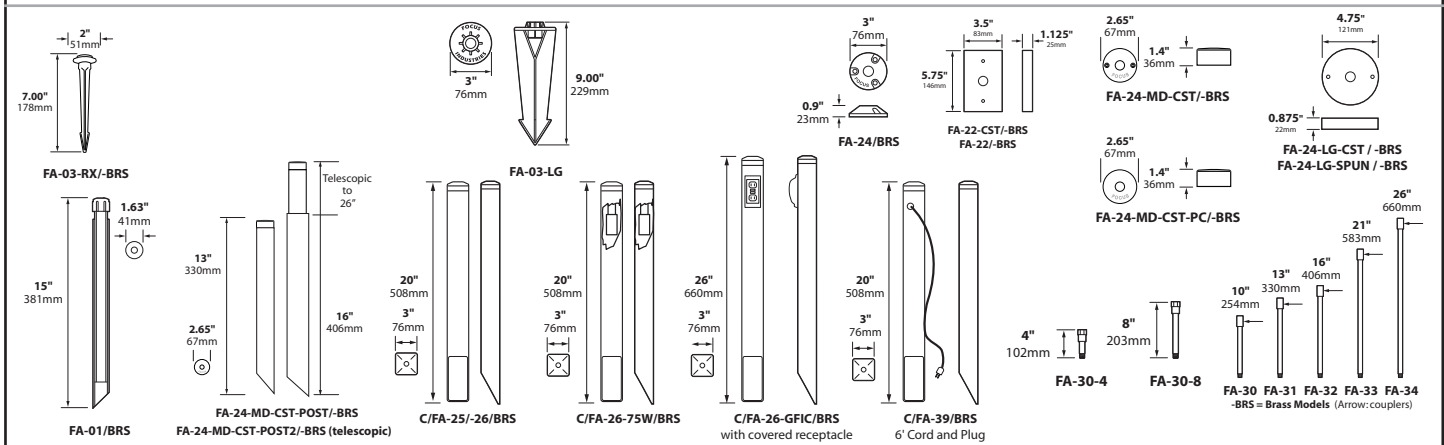

BEAM/GLARE CONTROL ACCESSORIES

- FA-08-21 Round 1/8" Black Hex Cell Louver
- FA-11-BLUE Blue Tempered Flat Glass Lens
- FA-11-GREEN Green Tempered Flat Glass Lens
- FA-11-AMBER Amber Tempered Flat Glass Lens
- FA-11-RED Red Tempered Flat Glass Lens
- FA-98-36C16 Linear Spread Tempered Glass Lens
- FA-104-SB Wide Spread Sand Blasted Glass Lens

JOB INFORMATION	
Type:	Date:
Job Name:	
Cat. No.:	
Lamp(s):	
Specifier:	
Contractor:	
Notes:	

FOCUS INDUSTRIES INC.®
25301 COMMERCENTRE DRIVE
LAKE FOREST, CA 92630

www.focusindustries.com
sales@focusindustries.com
(949) 830-1350 • FAX (949) 830-3390

Black Texture (Standard)	Antique Verde	Bronze Texture	Camel	White Texture	Hunter Texture	Rust	Weathered Iron	Weathered Brown	Stucco	Rubbed Verde	Chrome Powder	Acid Rust	Acid Verde	Black Acid Treatment
-BLT	-ATV	-BRT	-CAM	-WTX	-HTX	-RST	-WIR	-WBR	-STU	-RBV	-CPR	-BAR/CAR	-BAV/CAV	-BAT



DIRECTIONAL LIGHTS RXP-03/-04 SERIES



TYPE

LIGHT DISTRIBUTIONS AND PHOTOMETRICS

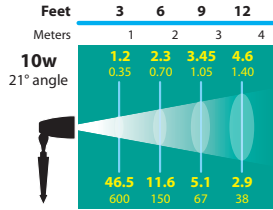

FL-13W-FG

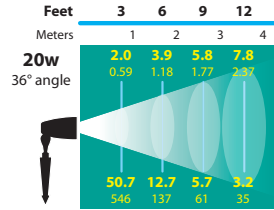

FL-13-BAB-FG

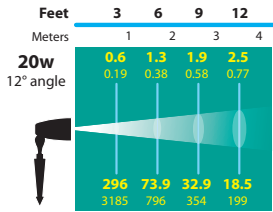

FL-13-ESX-FG

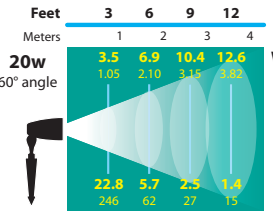

FL-13-VWFL-FG

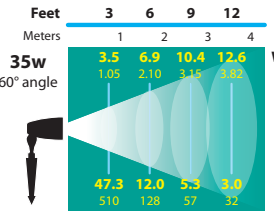

FL-15-FMW-60-FG

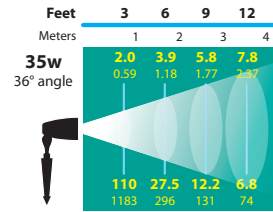

FL-15-FMW-ULTRA

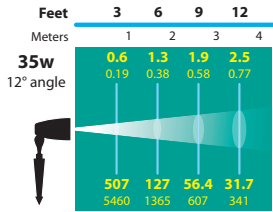

FL-15-FMT-FG

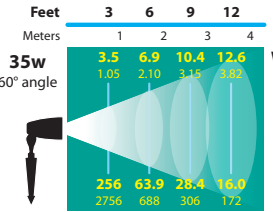

**FL-15-FMV-FG
FL-15-FMV-ULTRA**

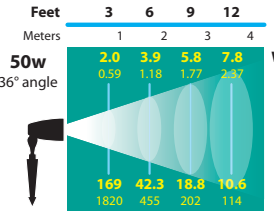

**FL-10-EXN-FG
FL-10-EXN-ULTRA**

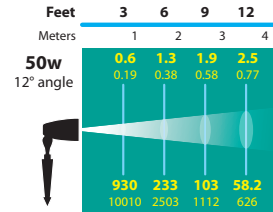

**FL-10-EXT-FG
FL-10-EXT-ULTRA**

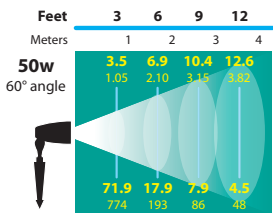

FL-10-VWFL-FG

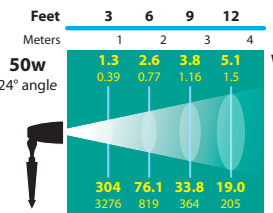

FL-10-EXZ-ULTRA

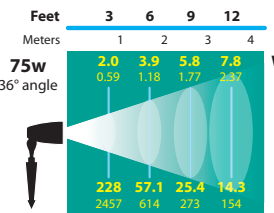

FL-13-EYC-FG

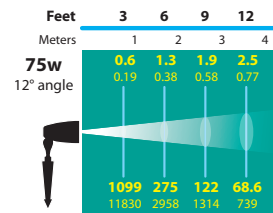

FL-20-EYF-FG

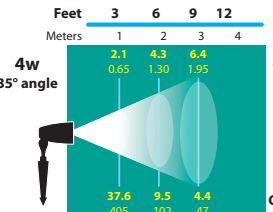

FL-LED-MR16-BAB

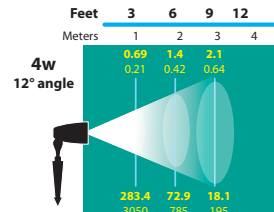

FL-LED-MR16-ESX

Black Texture (Standard)	Antique Verde	Bronze Texture	Camel	White Texture	Hunter Texture	Rust	Weathered Iron	Weathered Brown	Stucco	Rubbed Verde	Chrome Powder	Acid Rust	Acid Verde	Black Acid Treatment
-BLT	-ATV	-BRT	-CAM	-WTX	-HTX	-RST	-WIR	-WBR	-STU	-RBV	-CPR	-BAR/CAR	-BAV/CAV	-BAT