

CUSTOMER REFERENCE DRAWING

REV.	ECN # IF APPLIC.	REVISION DESCRIPTION	REQD. BY	DRAFTER	DATE
	NA	ORIGINAL RELEASED VERSION	NA	AC	6/27/14

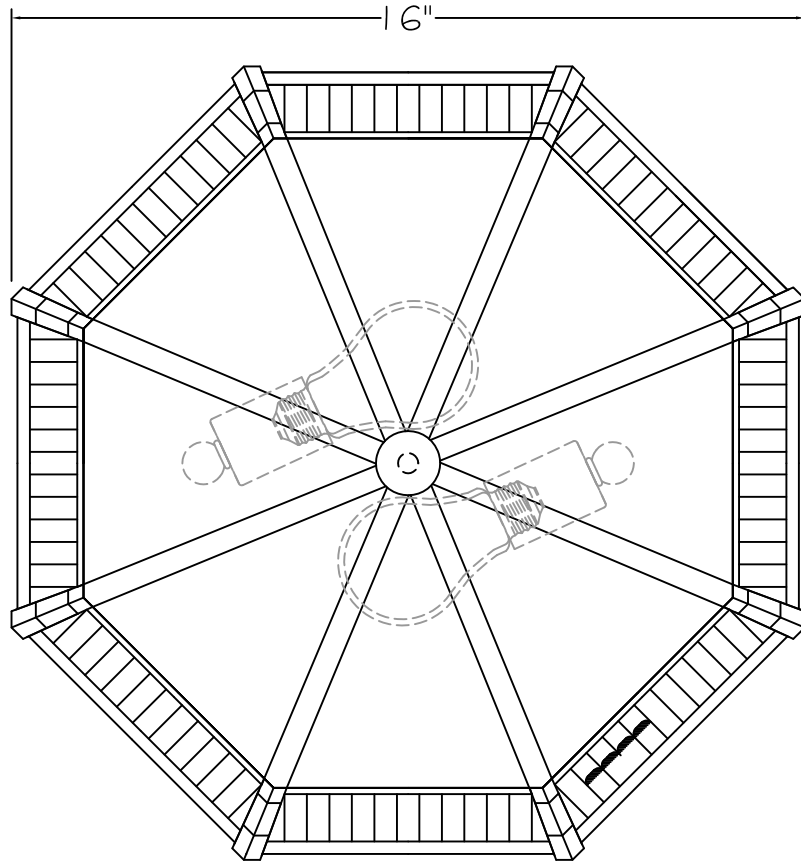

BOTTOM VIEW

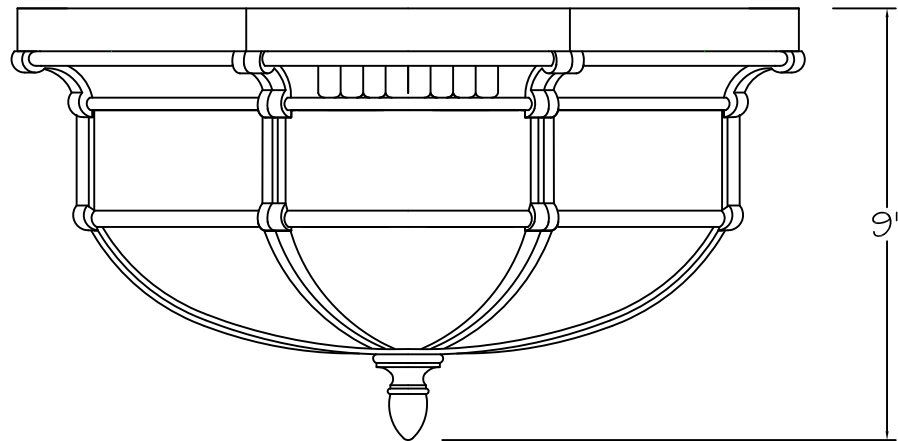

FRONT VIEW



This drawing and specifications are the exclusive property of BLUMBERG INDUSTRIES, INC. issued in strict confidence and shall not, without the prior written permission of BLUMBERG INDUSTRIES, INC., be produced, copied or used for any purpose whatsoever except the manufacture articles for FINE ART LAMPS.

5770-5772 Miami Lakes Dr. East / Miami Lakes, FL 33014
Ph: (305) 821-3850 FAX: (305) 821-1564

STYLE NUMBER: 845282ST

PART NUMBER: