



**PROFESSIONAL
OUTDOOR LIGHTING**

Type:

Model:

Project:

SPECIFICATION SHEET

MODEL 2132 Landscape Series • Brass & Copper • Path & Spread Lights

FIXTURE SPECIFICATIONS:

HOUSING:

Spun solid copper or brass shade with a precision CNC-machined, Twist-to-Lock solid brass lamp base for easy tool-free lamp access.

STEM:

1/2" heavy-gauge, extruded, solid copper or brass pipe with 1/2" NPT.

FINISH:

Brushed natural copper, natural brass or Olde Brass finish. (Brushed copper will rapidly age to an elegant rich bronze-like color and may develop areas of patina over time.)

SOCKET/LAMP HOLDER:

Top grade ceramic socket with nickel contacts, stainless steel springs, and Teflon-jacketed wire leads.

LENS:

Panoramic Plus - Wave shaped, textured, Tuffak® lens for superior light distribution.

LAMP TYPE:

T3 - 20W maximum. LN-10 T3 Halogen (10W) Standard.

MOUNTING:

Bottom of stem threaded with 1/2" NPT. Fixture may be mounted into threaded hubs in junction boxes, ground stakes, or floor-mounting canopies.

FASTENERS:

All fasteners are stainless steel.

WIRING:

Prewired with a three-foot pigtail of 18-2 direct-burial cable and underground connectors for a secure connection to supply cable.

CERTIFICATION:

UL Listed to U.S. and Canadian safety standards for low voltage landscape luminaires (UL 1838). Maximum wattages allowed by Underwriters Laboratories (UL) for U.S. and Canadian markets may vary. Maximum wattages specified are Underwriters Laboratories U.S. standard. Please contact Vista for any questions about maximum wattages allowed by UL Canadian standards.

All Vista luminaires are [MADE IN U.S.A.](#)

This fixture is also available as a LED luminaire. Please refer to LED Specification Sheet - 2132-LED.

DIMENSIONS:

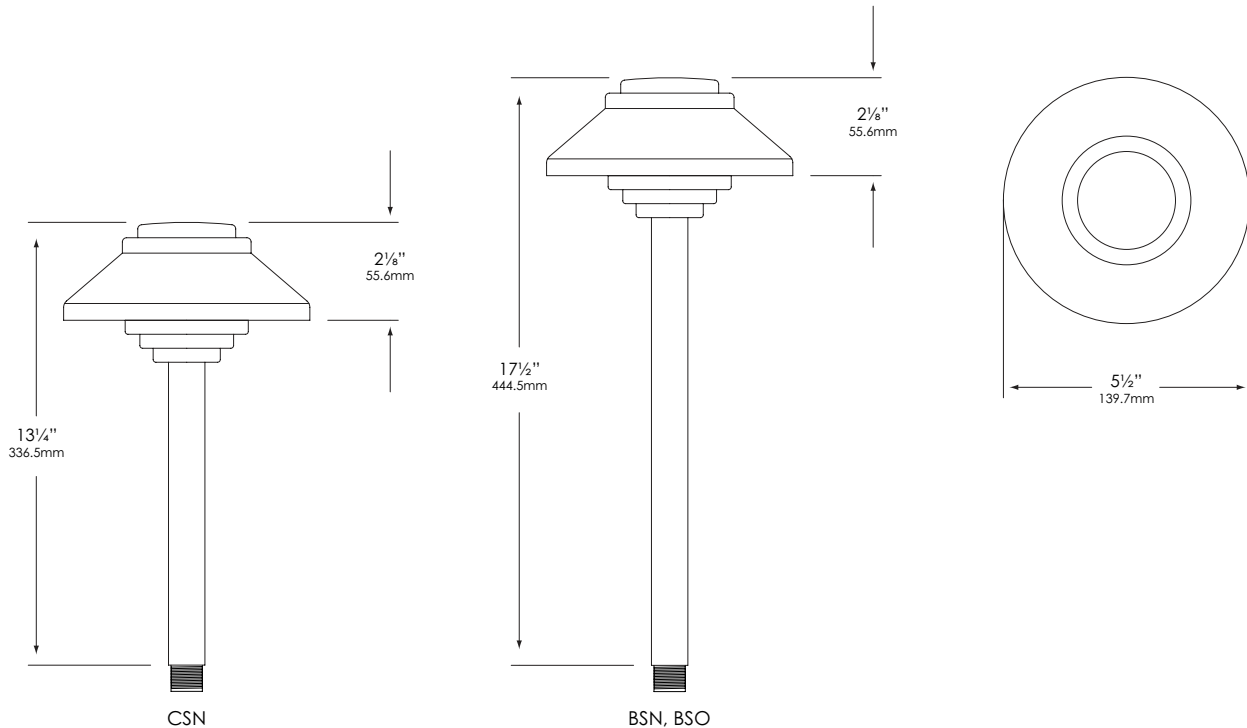

Vista Professional Outdoor Lighting reserves the right to modify the design and/or construction of the fixture shown without further notification.



SPECIFICATION SHEET

MODEL 2132 Landscape Series • Brass & Copper • Path & Spread Lights

FIXTURE ORDERING INFORMATION

TO ORDER FIXTURE: Select appropriate choice from each column as in the following example.

EXAMPLE: PR-2132-CSN-10T3

MOUNTING	MODEL	FINISH	LAMP
PR- ABS ground stake	2132	CSN - Natural Copper BSN - Natural Brass BSO - Olde Brass	5T3 - 5 W 10T3 - 10 W 20T3 - 20 W T3 Halogen 20W Maximum LN-10 T3 Halogen (10W) Standard 2.5-W-T3 LNT3-2.5-W-G-LED W-LB2ND - Warm 2.5W N-LB2ND - Neutral 2.5W C-LB2ND - Cool 2.5W W-LB5ND - Warm 5W N-LB5ND - Neutral 5W C-LB5ND - Cool 5W <i>(Please see lamp order code column on lamp guide, Vista product catalog.)</i>

Fixtures shipped with standard lamp, unless otherwise specified.
 Fixtures shipped with specified mounting hardware.
 Note: Optional custom length stems available. Consult local distributor.